

EURO

S90

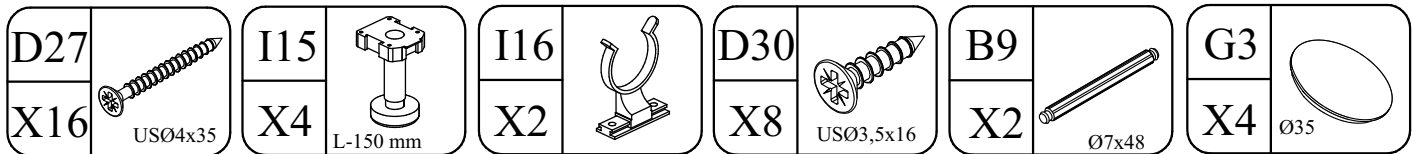

EURO S90

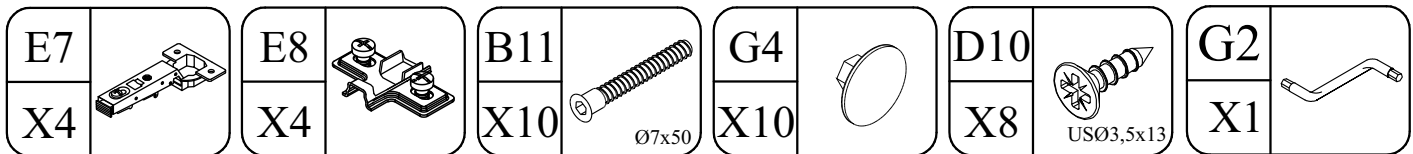
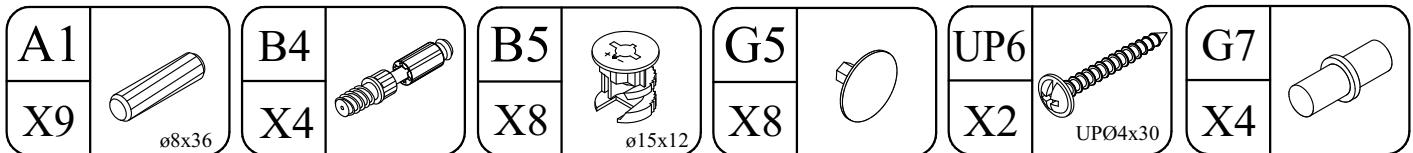
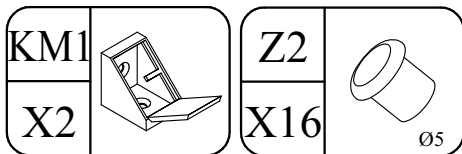
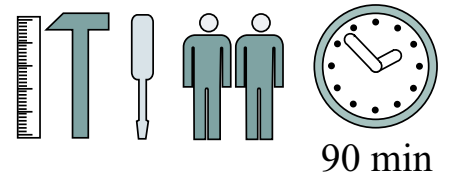
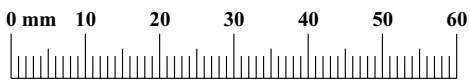
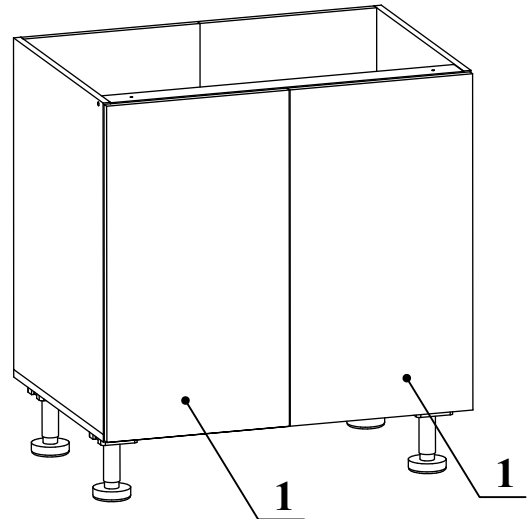
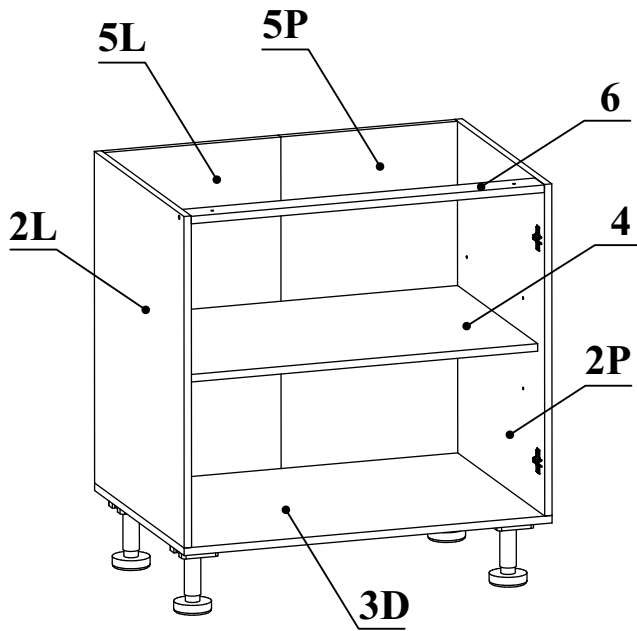
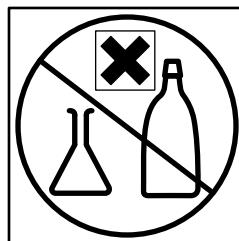
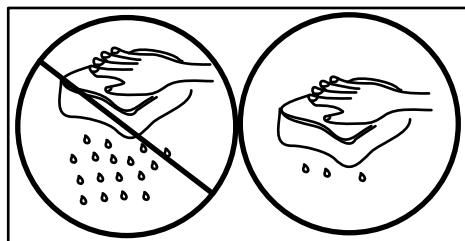
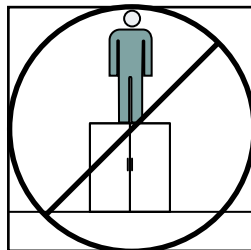
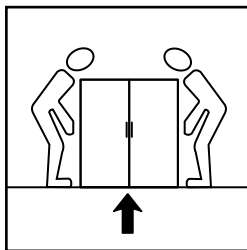
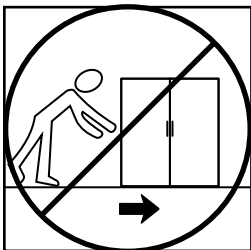
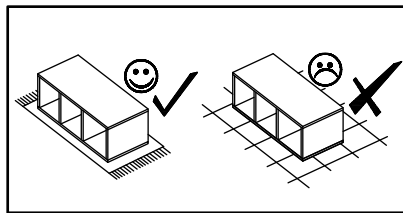
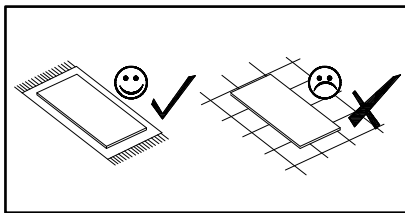
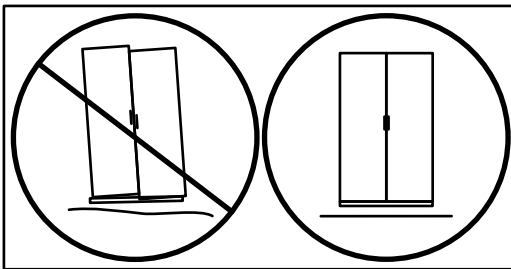
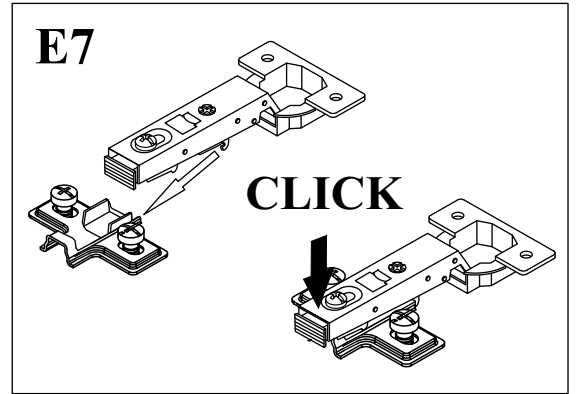
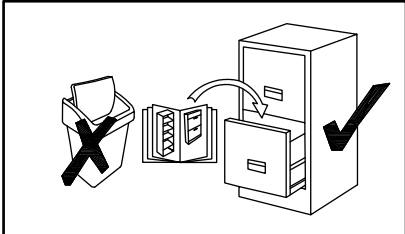
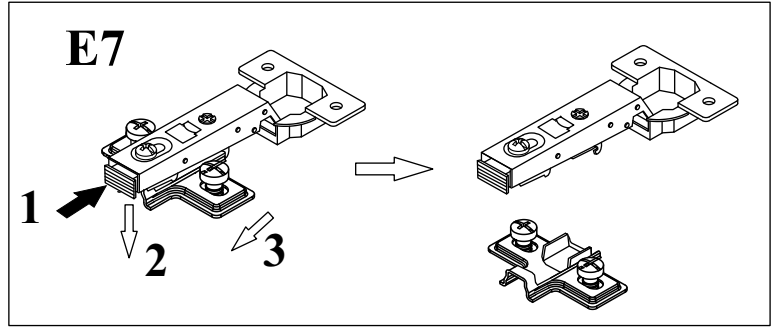

EURO S90

1

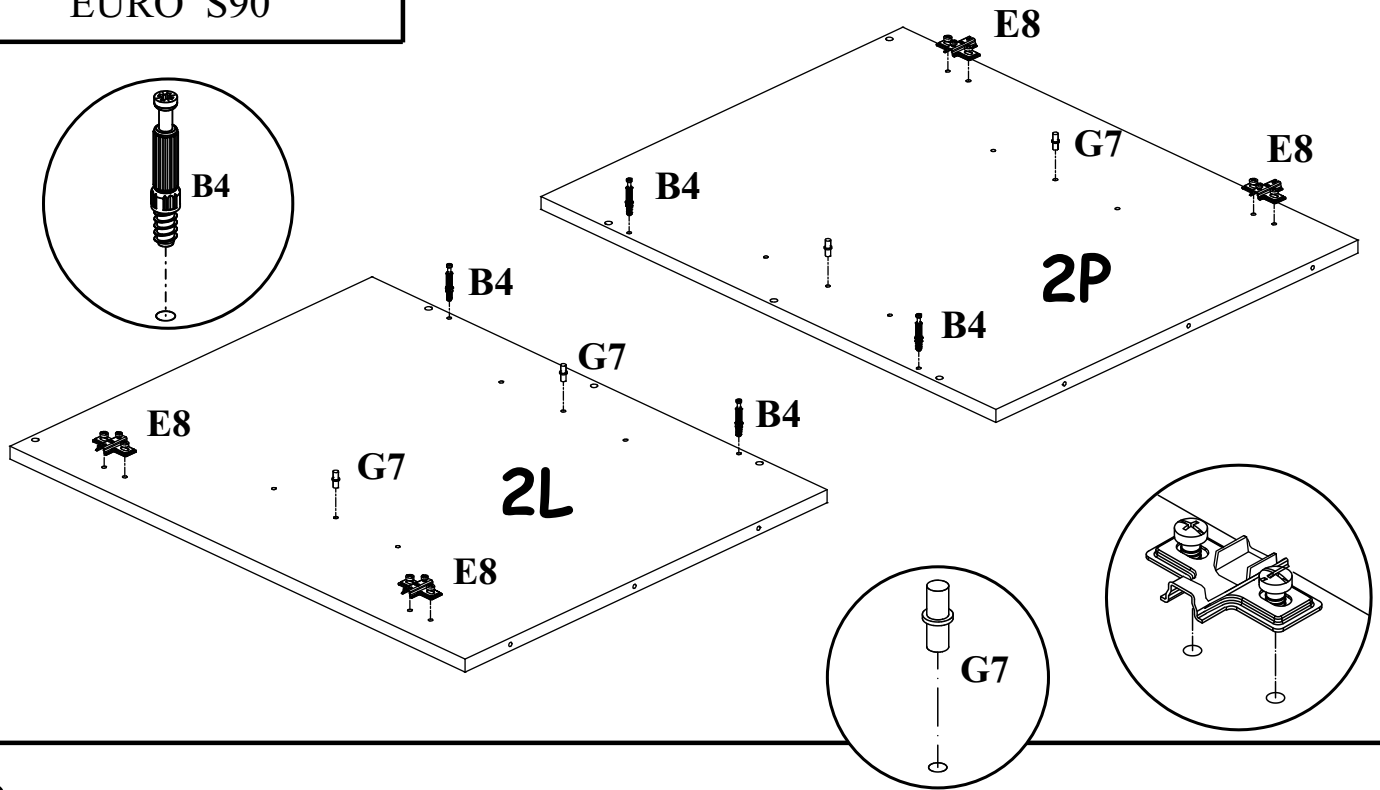

2

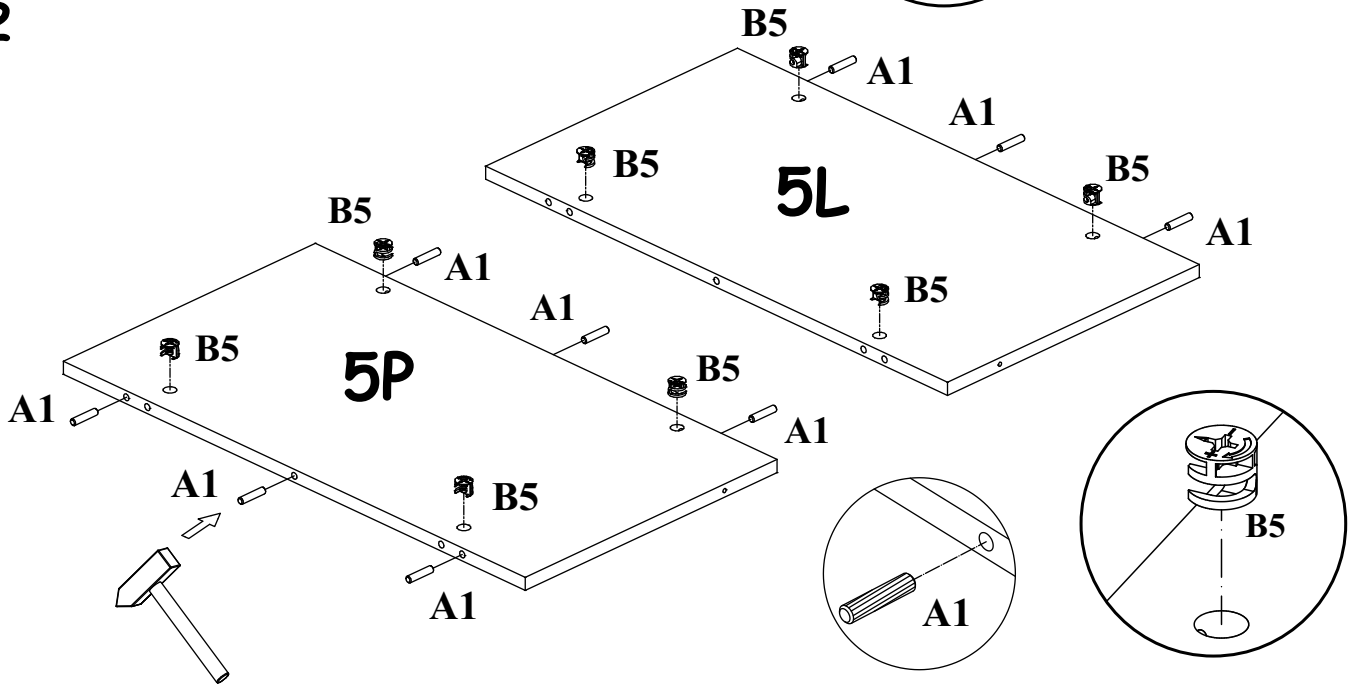

3

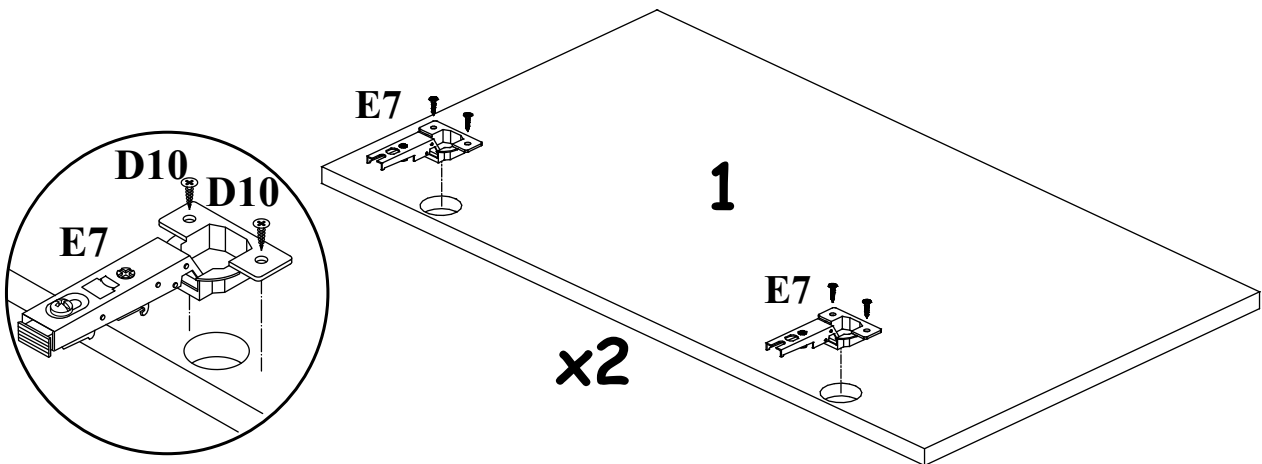

EURO S90

4

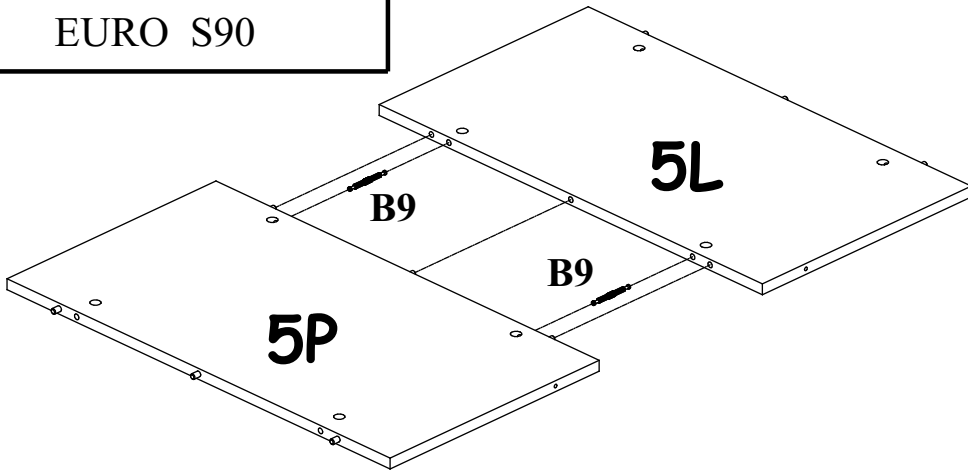

5

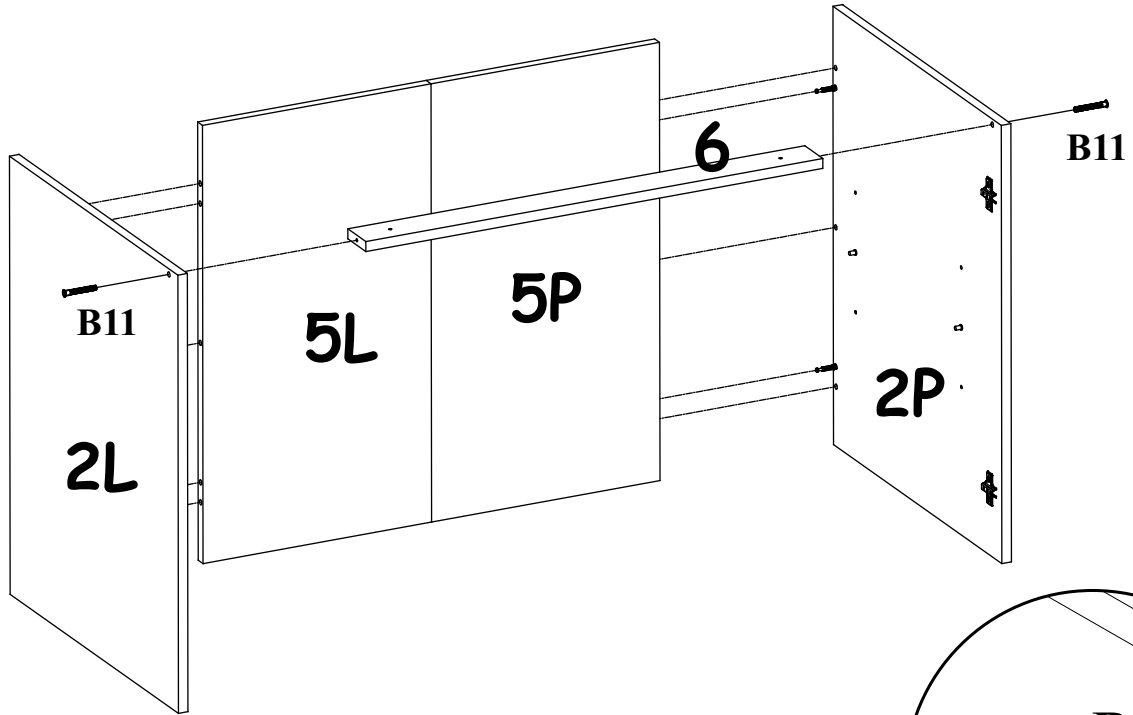

6

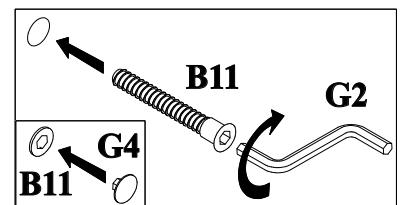
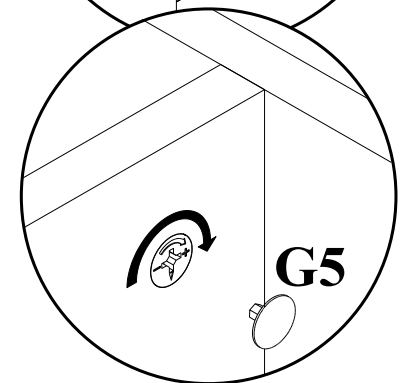
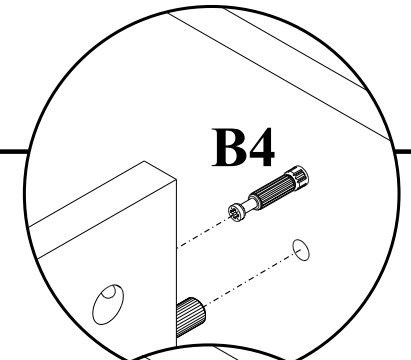
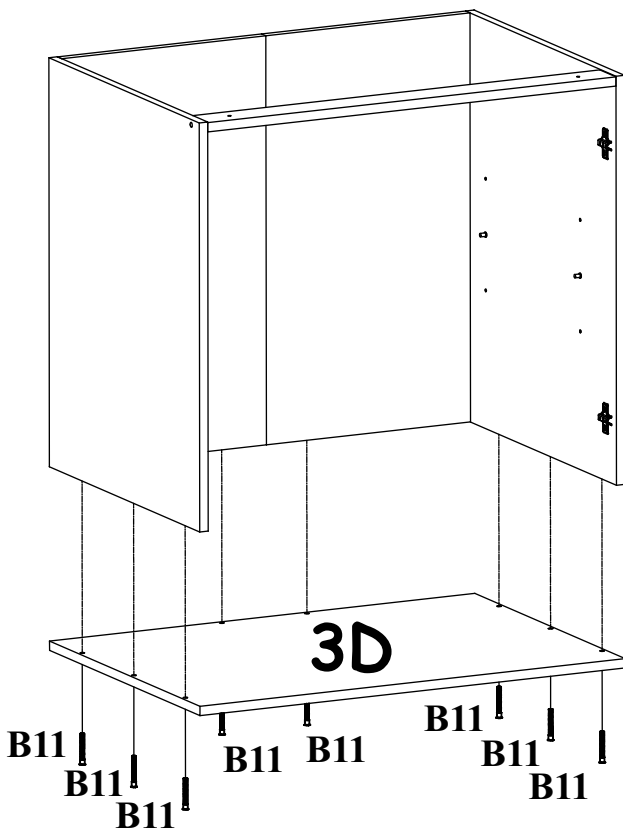

7

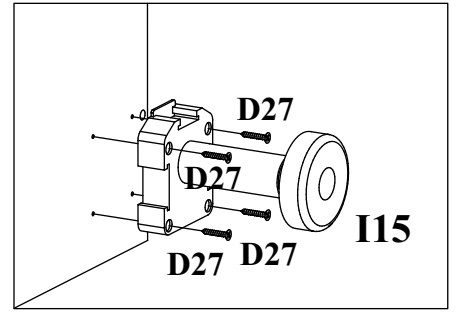
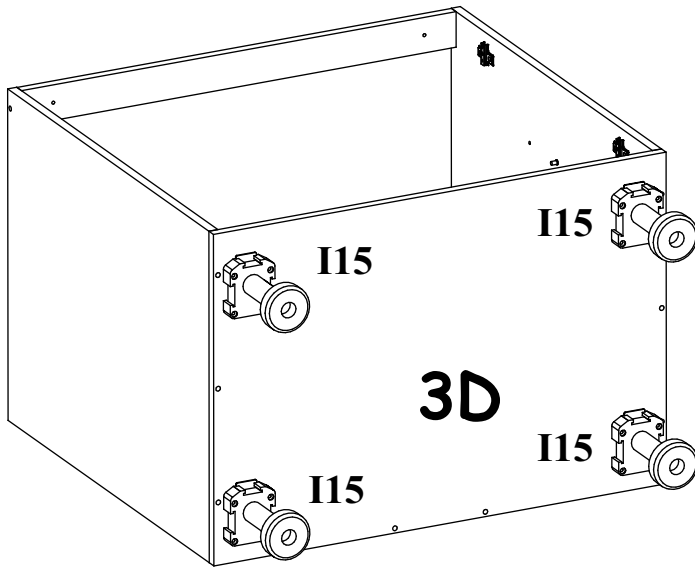

8

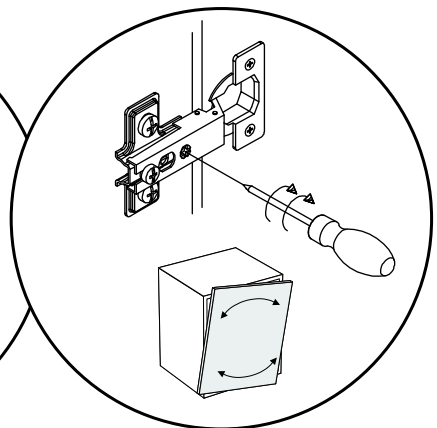
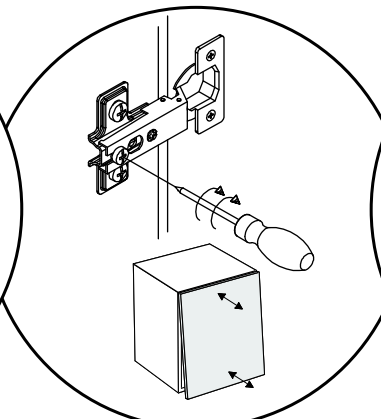
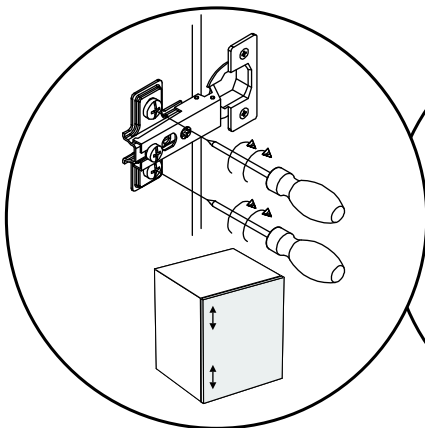
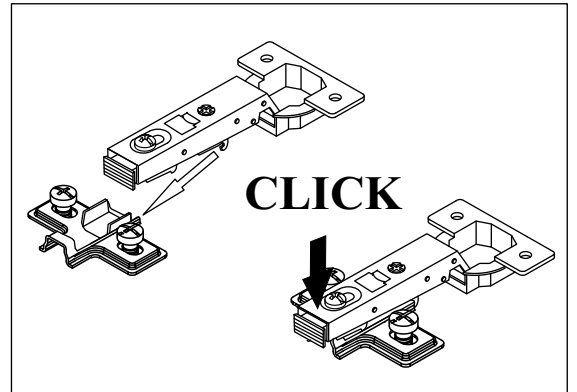
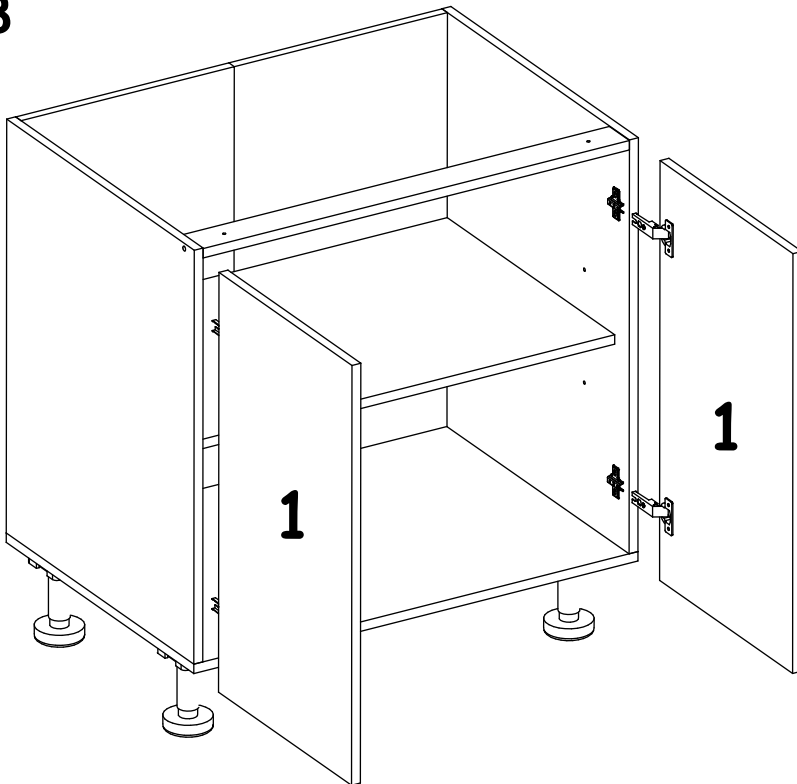

9

